

AMO UWB Module (SR040 with embedded antenna)

Rev 0.1
(ASMOP1CO0A1)

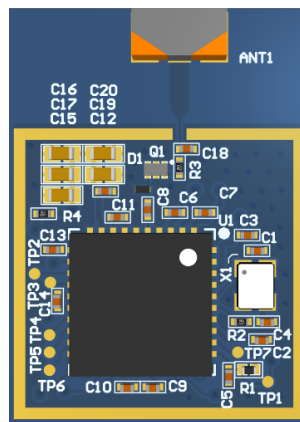

Revision	Contents	Date
0.1	New	7th, September, 2020.

7th, September, 2020

AMONSENSE Co., LTD.

Notes

The contents of this data sheet are subject to change without notice. Please confirm the specifications and delivery conditions when placing your order.

Table Of Contents

- 1. Introduction**
 - 1.1 Key Features
 - 1.2 Applications

- 2. Part Numbering**

- 3. Module Block Diagram**

- 4. Electrical Characteristics**
 - 4.1 Absolute Maximum Ratings
 - 4.2 Transmitter Power Table
 - 4.3 RF Characteristics

- 5. Module Package**
 - 5.1 Pinout Description
 - 5.2 Pin Description Box
 - 5.3 Module Dimensions or Footprint

- 6. Packing**

- 7. Soldering Condition**
 - 7.1 Manual Soldering – Pb Free
 - 7.2 Recommended Reflow Condition – Pb Free

1. Introduction

The UWB module is based on NXP's SR040 Ultra Wideband (UWB) transceiver IC. It integrates all RF circuitry, power management and clock circuitry in one module compliant to IEEE 802.15.4 HRP UWB PHY.

It can be used for 2-way ranging measurement and TDoA based one way ranging. Embedded PHY and MAC are compatible with FiRa consortium specification.

1.1 Key Features

AMO UWB SR040 Module with embedded antenna	
	
ANT Type	• Internal Antenna
Size	• 13mm x 18 mm x 2.3mm
Interface	• SPI(Host)
Main ICs	• SR040, ARM® Cortex-M33 32 Bit processor (SR040 comes with onboard flash to accommodate fixed FW.)
Reference Clocks	• 55.2MHz clock
Frequency Band	• 6.24 GHz ~ 8.24 GHz
Supply Voltage	• 1.8 to 3.6 (Typ. 3.3) V
Output Power	• MAX +12 dBm
Package	• Metal shield can

Table 1. Key Features

* Module and shield can size : 13mm x 18mm x 2.3mm

Copyright © 2010 AMOSENSE Co., Ltd.

AMOSENSE Confidential. All characteristics and specifications are subject to change without notice.

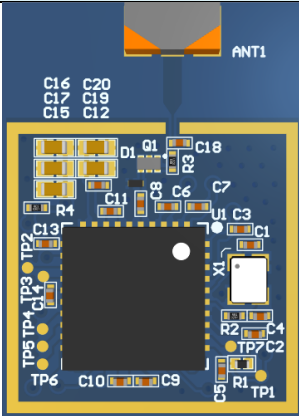
<http://www.amosense.co.kr>

1.2 Applications

- ① IOT application
- ② UWB Trackers
- ③ UWB Tags

2. Part Numbering

[Example]

Device Family

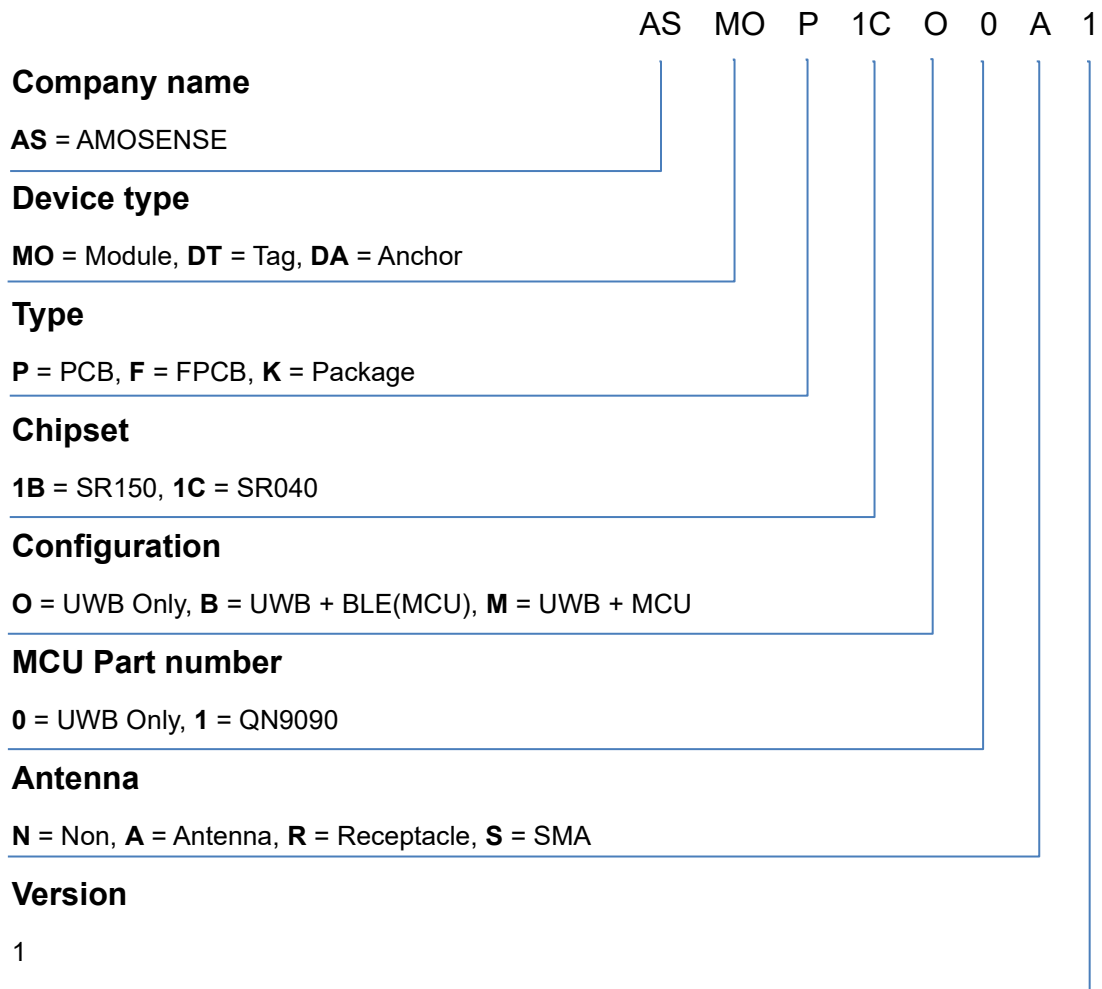

Note : Provisional designation

3. Module Block Diagram

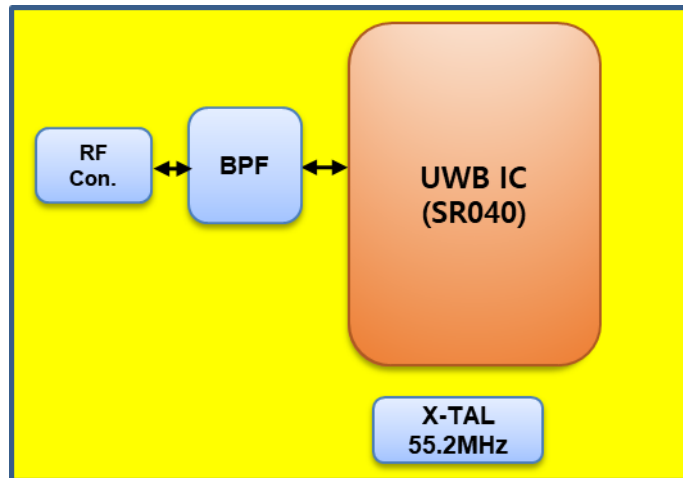

Figure 1. Block Diagram of AMO UWB Module

4. Electrical Characteristics

4.1 Limiting values

Parameter	Min	Typ.	Max	Unit
Supply Voltage(VDD)	1.8	3.3	3.6	V
Operating Temperature	-30	25	+85	°C
RF Input Power(UWB signal)	-20	-	-	dBm

Table 2. Absolute Maximum Ratings

4.2 Transmitter Power Table

- T = 25°C, VDD = 3.3 V (typ.)

Power table	
Tx Power	Max. 12 dBm

Table 3. TX Power

4.3 RF Characteristics

- T = 25°C, VDD = 3.3 V (typ.)

Parameter	Condition	Min	Typ.	Max	Unit
Frequency Range		6.24	-	8.24	GHz
TX Output Power	Programmable transmitter output power		12		dBm
RF Sensitivity	6.8 Mbps Data rate		TBD		dBm
Current Consumption	Single RX	-	TBD		mA
	TX 12dBm	-	TBD		mA
	Sleep Mode	-	-	TBD	uA
	SR040 is dedicated to battery operated UWB devices, embedded PMU enable operation from a coin cell battery				

Table 4. RF Characteristics

5. Module Package

5.1 Pinout Description

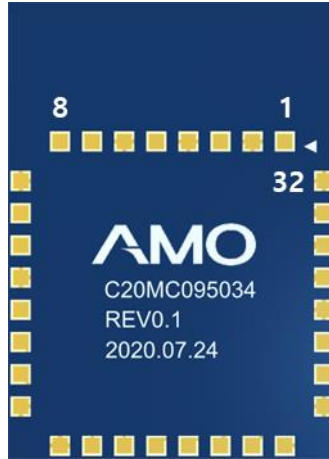

Figure 2 : Pinout Description(Bottom View)

5.2 Pin Description Box

PIN	PIN Name	PIN Type	Description
P1	NC		
P2	GND	G	Ground supply
P3	NC		
P4	GND	G	Ground supply
P5	RF_TX/RX1	RF	TX/RX
P6	GND	G	Ground supply
P7	NC		
P8	NC		
P9	GND	G	Ground supply
P10	NC		
P11	NC		
P12	GND	G	Ground supply
P13	NC		
P14	RST_N	I	Reset input
P15	RDY_N	I/O	Ready output
P16	GND	G	Ground supply
P17	GND	G	Ground supply
P18	INT_N	I/O	Interrupt output

P19	PA_ENBL	I/O	Gating signal for an optional external PA
P20	SPI_MISO	I/O	MISO connection for the SPI host interface
P21	SPI_MOSI	I/O	MOSI connection for the SPI host interface
P22	SPI_CS	I/O	Slave select connection for the SPI host interface
P23	SPI_SCK	I/O	clock for the SPI host interface
P24	GND	G	Ground supply
P25	GND	G	Ground supply
P26	NC	P	
P27	NC	I/O	
P28	GND	G	Ground supply
P29	VDD	P	3.3V Power supply
P30	VDD	P	3.3V Power supply
P31	VDD	P	3.3V Power supply
P32	GND	G	Ground supply

Table 5. Pin Description

5.3 Module Dimension or Footprint

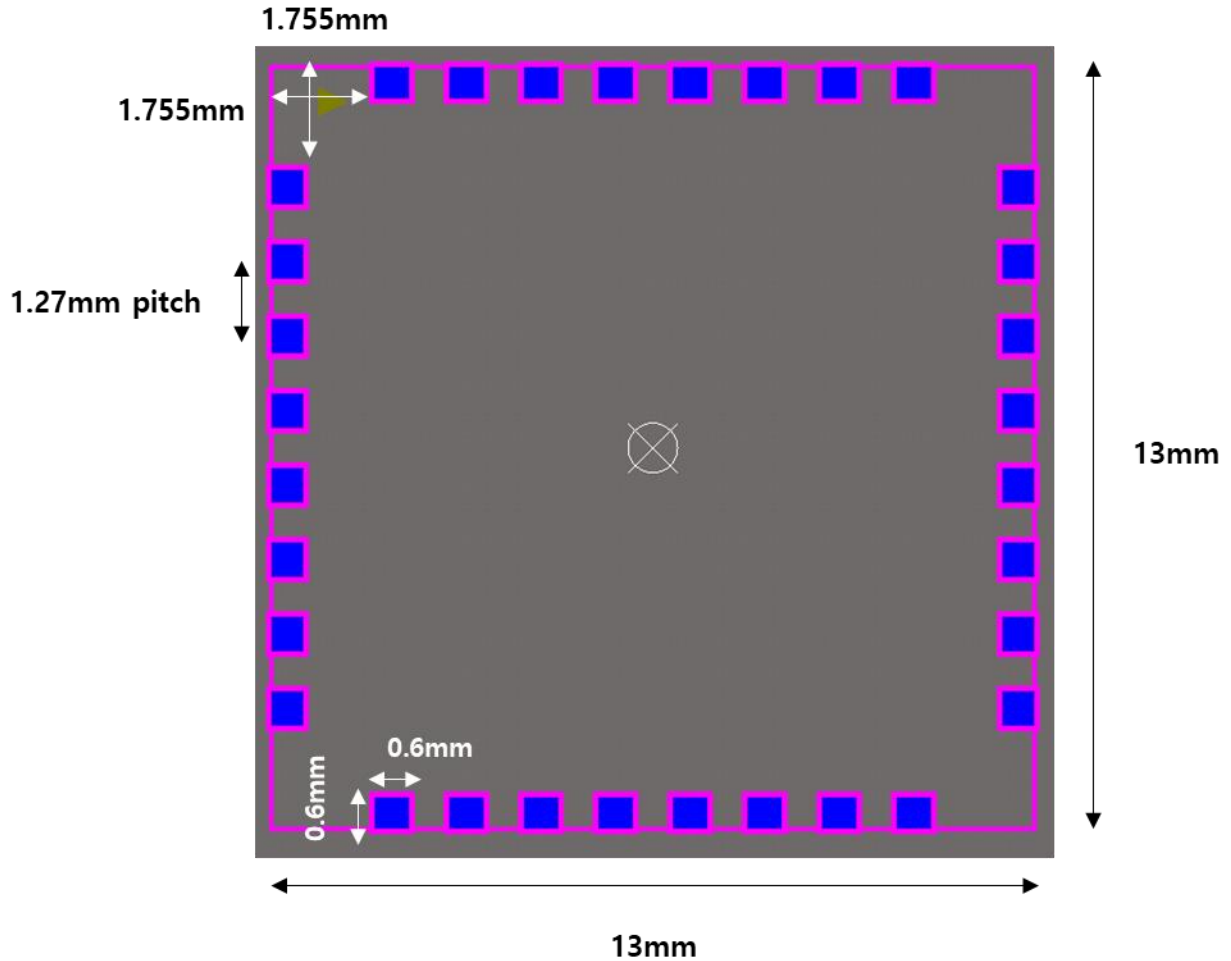

Figure 3. Pin Dimension or Footprint

6. Packing

T.B.D

7. Soldering Condition

7.1 Manual Soldering – Pb Free

- ① Soldering Temperature: $360^{\circ}\text{C} \pm 5^{\circ}\text{C}$, 5sec max.
 (Solder : Sn /Ag /Cu : 96.5 /3.0 /0.5)

7.2 Recommended Reflow Condition – Pb Free

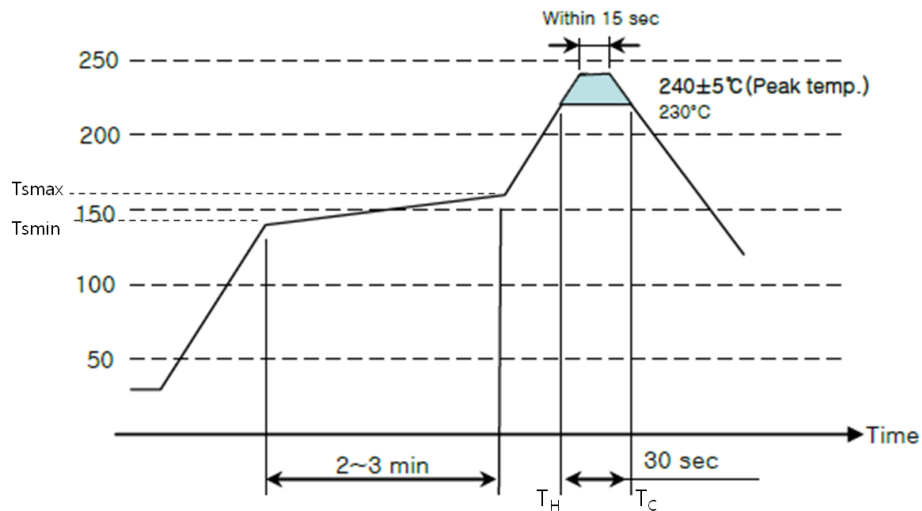

Profile Feature	Pb-Free Assembly
Preheat	
-Temperature Min (T_{smin})	-140°C
-Temperature Typical ($T_{stypical}$)	-150°C
-Temperature Max (T_{smax})	-160°C
-Time T_{smin} to T_{smax}	-2 ~ 3 min
Peak Temperature	240±5°C
Time of actual peak temperature	Max. 15 seconds
Heating to Cool	
-Temperature Heating (T_H)	-230°C
-Temperature Cool (T_C)	-230°C
-Time T_H to T_C	-30 seconds